

Article number: 20056558

Description: E+G Quick-fit coupling (radial displacement)
GN 240.1-M20x1,5-A

Measures

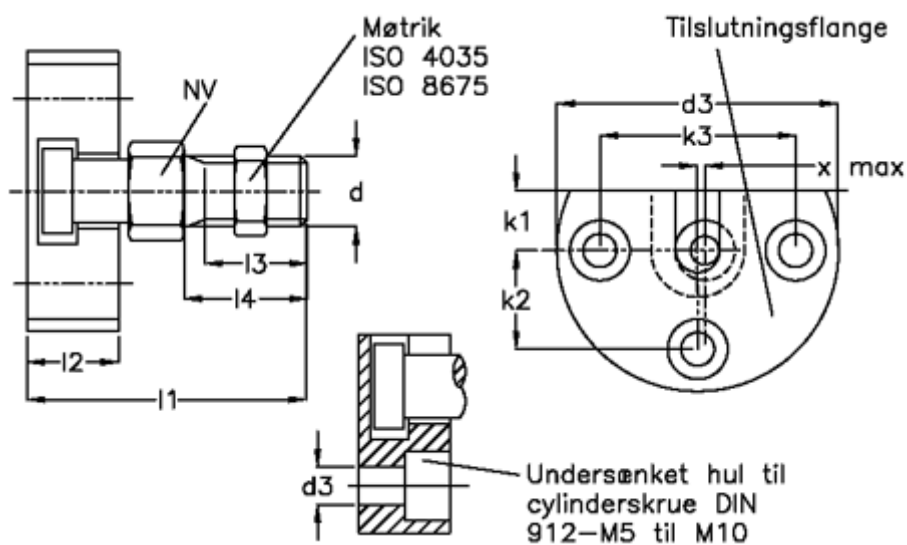

d1 = M 20x1,5	l3	= 26.0
d2 = 80	l4	= 35
d3 = 11.0	Max displacement	= 1.0
k1 = 17.0	Max push-pull strength N	= 30000
k2 = 28.0	NV	= 30
k3 = 56		
l1 = 74.0		
l2 = 26.0		